

# eMotio & eMotio+

ELECTRICAL EXAMINATION COUCH



eMotio+



eMotio



## eMotio & eMotio+ INNOVATION FOR PRACTICES

The all-electric eMotio couch is the most efficient examination couch ever designed, with the aim of becoming the new assistant for the general practitioner and specialist. Promotal carried out the largest study ever conducted in medical furniture with 200 doctors from 6 European countries.

The final product, the result of three years development, allows the doctor to fully concentrate on the diagnosis, whilst gaining time and space. The patient benefits from increased comfort and lower stress for a more balanced exchange.



*Easy access  
around the couch*

## eMotio

*Chair and couch positions  
reached with 1 click*

*Variable height  
from 45 to 96cm  
(105cm with the Tilt)*

*High comfort upholstery*

## WITH eMotio & eMotio+, PROMOTAL REINVENTS THE MEDICAL CONSULTATION AROUND 3 PILLARS :

### EQUALITY OF TREATMENT :

- > Welcome and examination in chair position
- > Low position up to **45 cm**
- > **Smooth, safe** electrical motions
- > **More balanced** relationship between the doctor and his patient
- > Folding assistance handles (not compatible with the eMotio+)
- > **High comfort** upholstery
- > Welcomes patients up to **205 kg**

### EFFECTIVENESS :

- > Your favourite positions **with one press**: two 100% configurable examination positions, return to welcome position, couch and chair positions
- > Fast, easy **access around the couch**
- > Gyneco position, with possibility of raising the pelvis **up to 105 cm**  
(Included for the eMotio+, as an option for the eMotio)

## AVAILABLE ACCESSORIES

Models	Convertible arm rests and leg rests	Adjustable headrest	Tilt
eMotio 4050-20	Accessory	Accessory	Option
eMotio+ 4055-20	●	●	●



2 fully configurable Quick Exam positions, that let you select your 2 favourite examination positions with 1 press

# eMotio+

Pedal controlled elevation



2-in-1 arm rests and leg rests  
ref. 40923



Pair of stirrups  
ref. 40850



Pair of base rails  
ref. 40878



Lamp bracket  
ref. 40950



Folding assistance handles  
(not compatible with the eMotio+)  
ref. 40922



Adjustable headrest  
ref. 11679-01

## AVAILABLE OPTIONS



Electrical gyneco tilt  
ref. 40300





















Integrated mains supply socket  
+ Equipotential terminal  
EUROPE, UK, US - ref. 40400-1  
DK, IT, AUS, CH - ref. 40400-2

### USE ERGONOMICS :

- > Welcome and favourite examination positions reached **with 1 click**
- > **All-electric:** height, effortlessly adjustable backrest and leg rest inclination
- > **Ergonomic controls:** control of elevation and trendelenburg (optional) by pedal and swivelling control panel
- > Low position **up to 45 cm**, high position **up to 96 cm**
- > Electrically activated castors by sustained contact
- > Pediatric & gyneco examination positions

AVAILABLE  
COLOURS

32 - BLUE		CLASSIC
93 - COTTAGE		
35 - RED		
34 - YELLOW		
91 - WHITE		
92 - MARINE		
56 - DARKNESS		
57 - ANTISTATIC		VITAMIN
64 - GRAPE		
67 - LAGOON		
66 - SWEET		
63 - CEDRAT		COSY
80 - SKY		
81 - SEA GREEN		
65 - LILAC		
96 - TIN		
82 - MOUSE GREY		
83 - NATURAL		
84 - CHOCOLATE		

eMotio  
&  
eMotio+

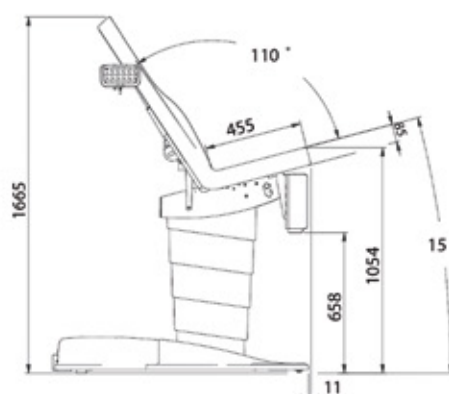
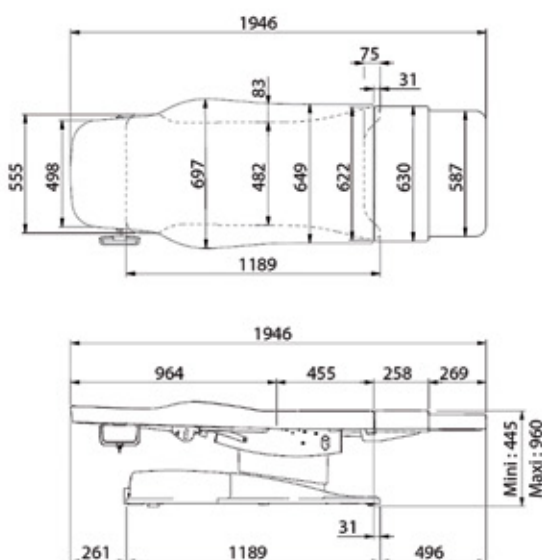

**EMOTIO 4050-20**

**EMOTIO+ 4055-20**

**GROSS WEIGHT : 175 KG**

**NET WEIGHT : 138 KG**

**VOLUME : 0,71 M<sup>3</sup>**



**PROMOTAL.COM**



22 rue de Saint-Denis-de-Gastines - 53500 Ernée, FRANCE

Phone : + 33 (0)2 43 05 68 95

Fax : + 33 (0)2 43 05 72 00